

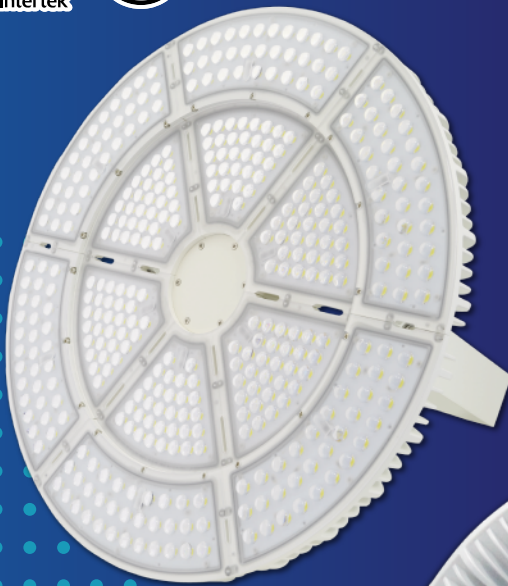

TOP HI-TECH CO., LTD.

Waterproof LED High Bay Light



500W



Specification Sheet

Design 2021 / 11



+886-2-2267-1234

sales@tht-ex.com

www.tht-ex.com

Product Features

THT's 500W High Bay Light with excellent thermal management, system efficacy reach 156 lm/W(Cold stage). With the features of light-weight, different mounting options and longer time service, it delivers the benefits of less maintenance and more economical solution. Ideal applications are for factories, supermarkets, warehouses and distribution centers.

- High system efficacy up to 156 lm/W(Cold stage).
- CRI Option available for 70 and 80.
- CCT option available for 3000K,4000K,5000K,6500K.
- Temperature range -30°C to +45°C.
- No IR-and UV radiation, low heat radiation.
- LED lifetime (L70) @55°C 60,000hrs.
- Significant energy savings.
- Flexible LED configurations.
- Multiple mounting options.

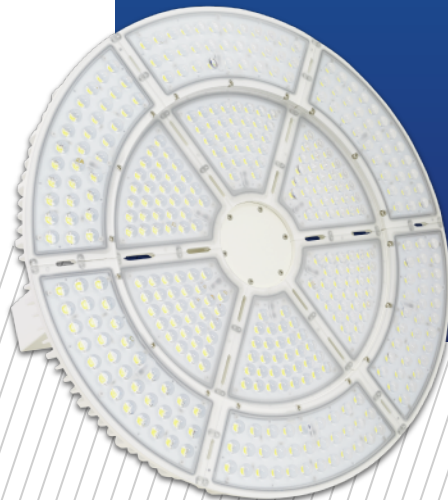

Specifications

Model No.	THTLADC050030H0XXX1	THTLADC050040H0XXX1	THTLADC050050H0XXX1	THTLADC050065H0XXX1
Color Temp.	3000K	4000K	5000K	6500K
Wattage (±10%)	500W	500W	500W	500W
Luminous Flux (±10%)	73,900 lm	77,800 lm	77,800 lm	73,900 lm
Lum. / Wat. (±10%)	148 lm	156 lm	156 lm	148 lm
Input Voltage	100V-277V	100V-277V	100V-277V	100V-277V
Net Weight	10.0 kgs / 22.0 lbs	10.0 kgs / 22.0 lbs	10.0 kgs / 22.0 lbs	10.0 kgs / 22.0 lbs
CRI	≥70Ra	≥70Ra	≥70Ra	≥70Ra
Lens	15°, 30°, 60°			
Dimming Options	0-10V dimming			
SPD	L/N 2.5KV ; L,N-FG 5KV			
IP Rating	IP65			
Operating Temp.	-30°C ~ +45°C			
Lifespan	LED lifetime (L70) @55°C 60,000 hrs.			
Warranty	5-year warranty			

Ordering Information

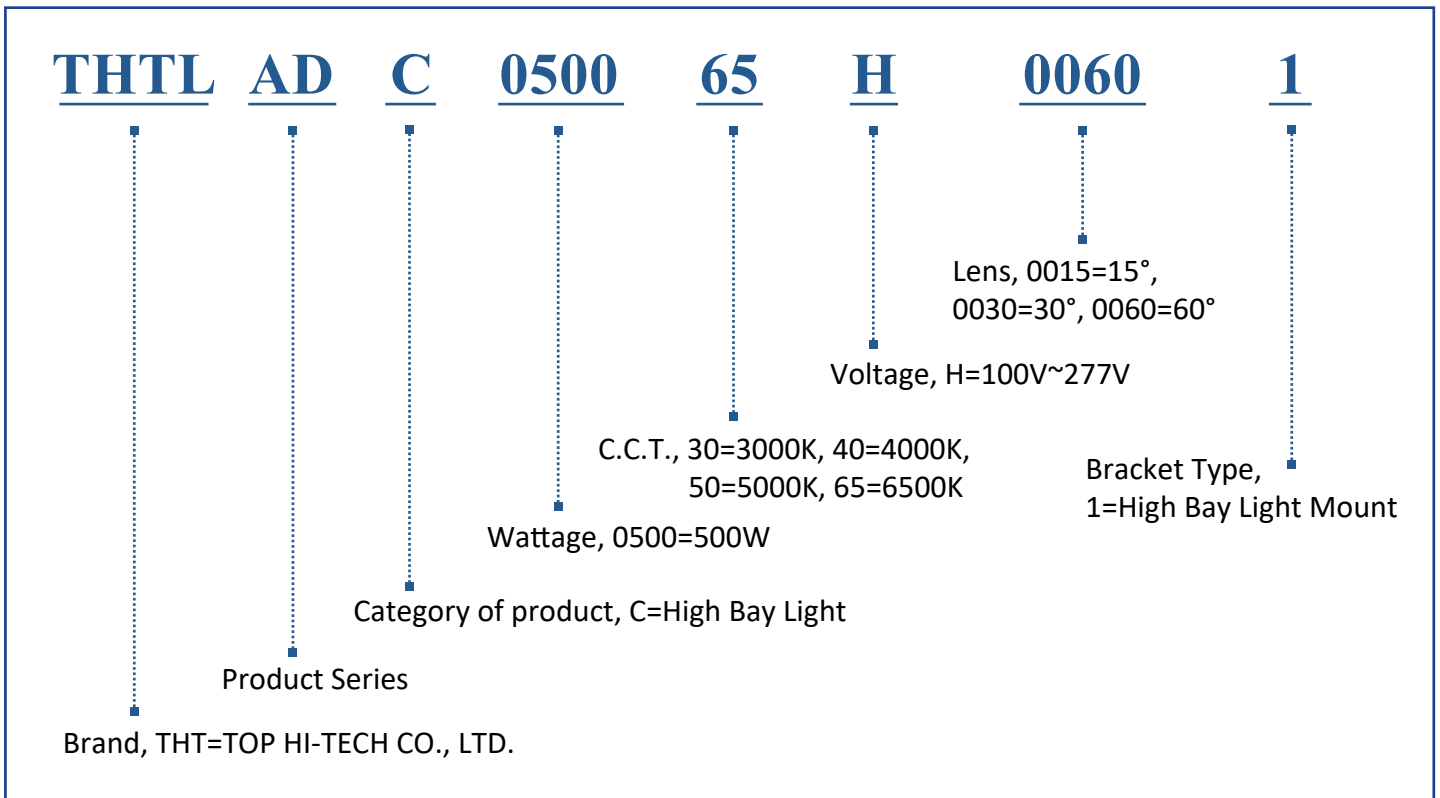

Light Pattern

15°

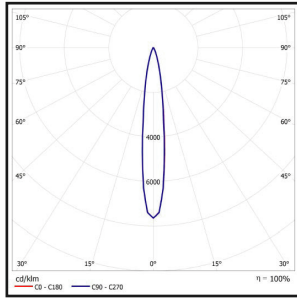

500W

LUX
(WD,C8)

3M	22334
6M	5584
9M	2482

30°

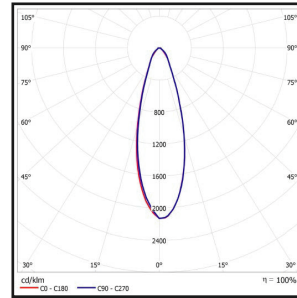

500W

LUX
(WD,C8)

3M	11022
6M	2756
9M	1225

60°

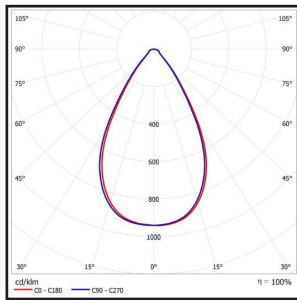

500W

LUX
(WD,C8)

3M	5106
6M	1277
9M	567

Dimension Drawing (All in mm)

STR Type

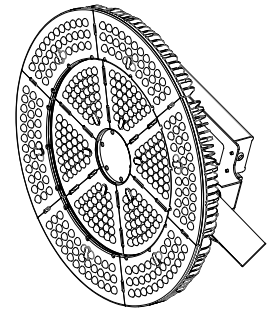
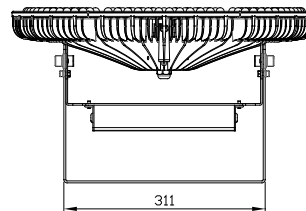
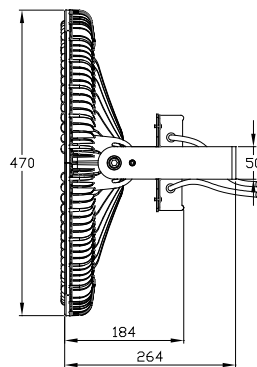
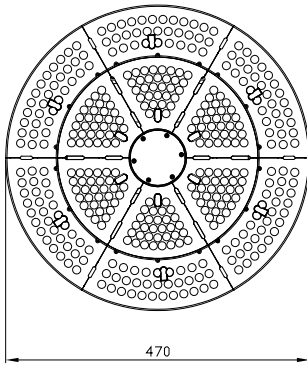

SPO Type

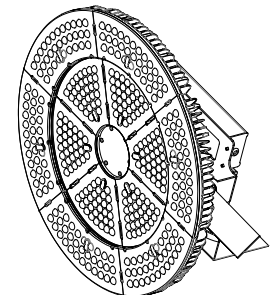
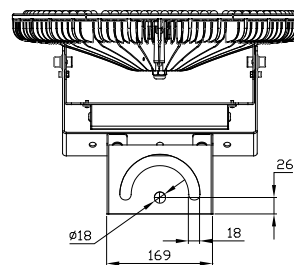
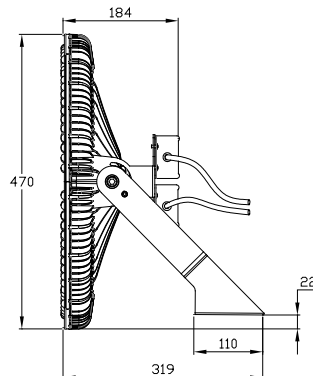
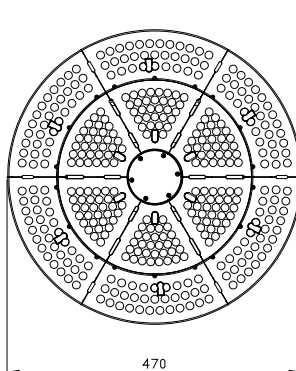



Application

- Industry
- Warehouse
- Commercial
- Convention Hall