



TOP HI-TECH CO., LTD.

# Waterproof LED Flood Light



80W, 100W



## Specification Sheet

Design 2021/ 03



+886-2-2267-1234

sales@tht-ex.com

www.tht-ex.com

# Product Features

THT's Flood Light is the high-efficiency lighting system manufactured in Taiwan. It provides quality and comfortable light for various industrial environments. It also has the versatility to be used both in the indoor and outdoor areas with IP66 protection.

The Flood Light offers customers an aesthetic design with exceptional performance and high reliability.

- High system efficacy up to 146 lm/W (Cold stage).
- CCT option available for 3000K, 4000K, 5000K, 6500K.
- Temperature range -30°C to +50°C.
- No IR- and UV radiation, low heat radiation.
- LED lifetime (L70) @55°C 60000hrs.
- Solid die-cast aluminum housing.
- Rotatable bracket made of stainless steel.
- UV rated powder paint coating.
- Equipped with symmetric and asymmetric optical lens.
- Replaceable driver (plug and play system).
- Significant energy savings.
- Flexible LED configurations.



# Specifications

## 80W

Model No.	THTLADA008030H0XXX0	THTLADA008040H0XXX0	THTLADA008050H0XXX0	THTLADA008065H0XXX0
Color Temp.	3000K	4000K	5000K	6500K
Wattage (±10%)	80W	80W	80W	80W
Luminous Flux (±10%)	12,400 lm	13,200 lm	13,200 lm	12,400 lm
Lum. / Wat. (±10%)	155 lm	165 lm	165 lm	155 lm
Input Voltage	100V-277V	100V-277V	100V-277V	100V-277V
Net Weight	4.1 kgs / 9.0 lbs	4.1 kgs / 9.0 lbs	4.1 kgs / 9.0 lbs	4.1 kgs / 9.0 lbs
CRI	≥80Ra	≥80Ra	≥80Ra	≥80Ra
Lens	60°, 120°			
Dimming Options	0-10V dimming			
SPD	L/N 2.5KV ; L,N-FG 5KV			
IP Rating	IP66			
Operating Temp.	-30°C ~ +50°C			
Lifespan	LED lifetime (L70) @55°C 60,000 hrs.			
Warranty	3-year warranty			

## 100W

Model No.	THTLADA010030H0XXX0	THTLADA010040H0XXX0	THTLADA010050H0XXX0	THTLADA010065H0XXX0
Color Temp.	3000K	4000K	5000K	6500K
Wattage (±10%)	100W	100W	100W	100W
Luminous Flux (±10%)	15,500 lm	16,000 lm	16,000 lm	15,500 lm
Lum. / Wat. (±10%)	155 lm	160 lm	160 lm	155 lm
Input Voltage	100V-277V	100V-278V	100V-277V	100V-277V
Net Weight	4.1 kgs / 9.0 lbs	4.1 kgs / 9.0 lbs	4.1 kgs / 9.0 lbs	4.1 kgs / 9.0 lbs
CRI	≥80Ra	≥80Ra	≥80Ra	≥80Ra
Lens	60°, 120°			
Dimming Options	0-10V dimming			
SPD	L/N 2.5KV ; L,N-FG 5KV			
IP Rating	IP66			
Operating Temp.	-30°C ~ +50°C			
Lifespan	LED lifetime (L70) @55°C 60,000 hrs.			
Warranty	3-year warranty			

# Ordering Information

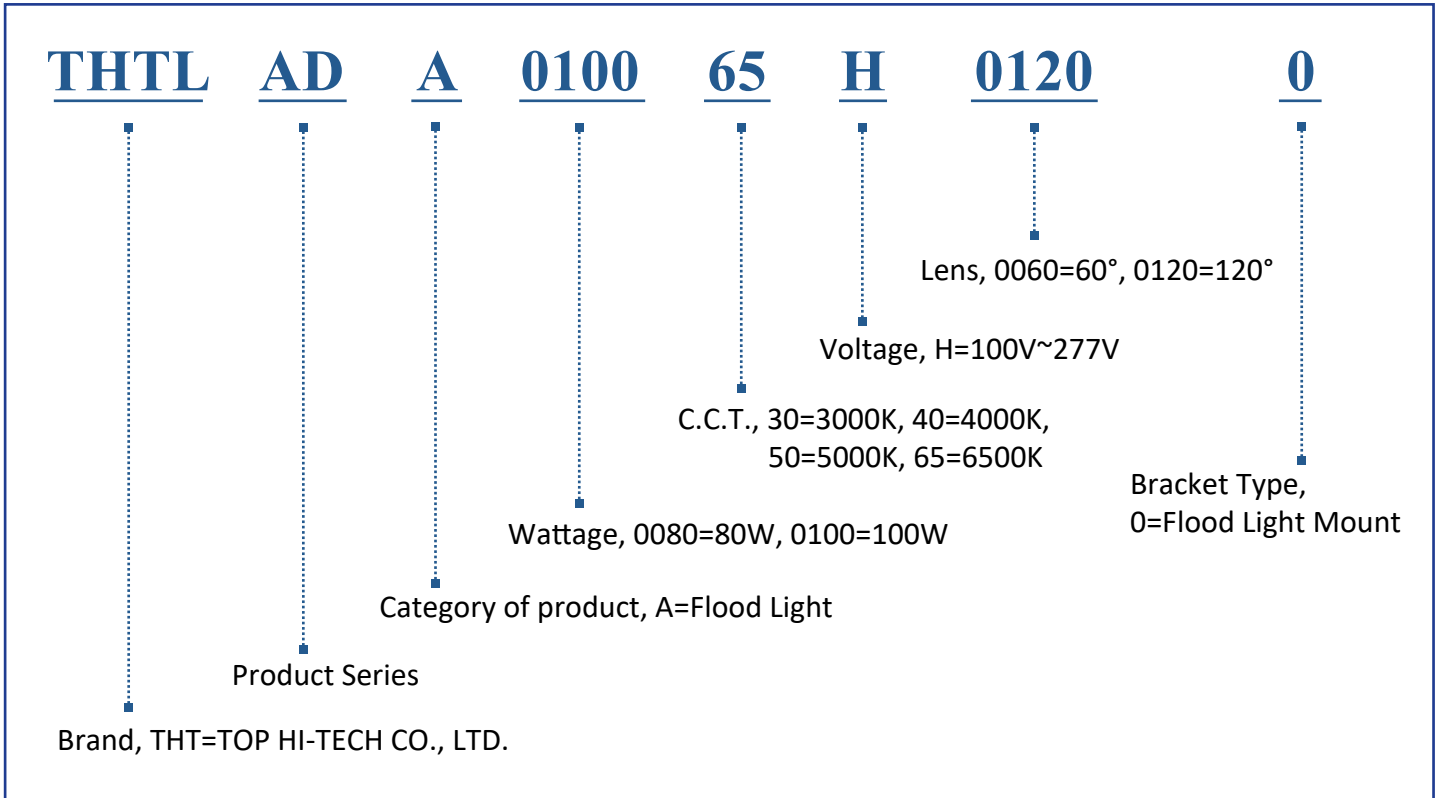

# Light Pattern

60°

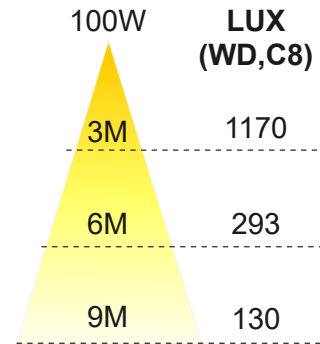
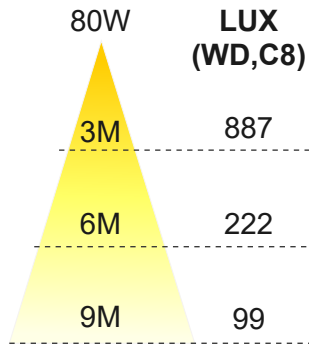
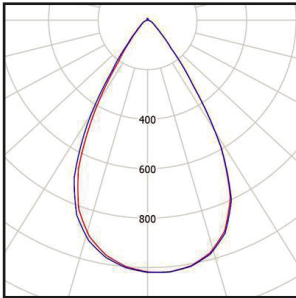

120°

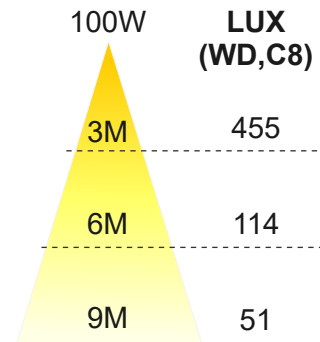
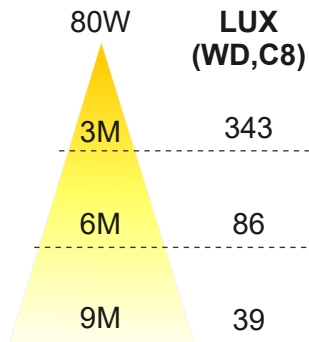
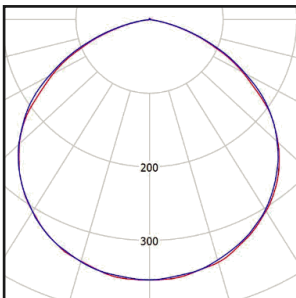

# Dimension Drawing (All in mm)

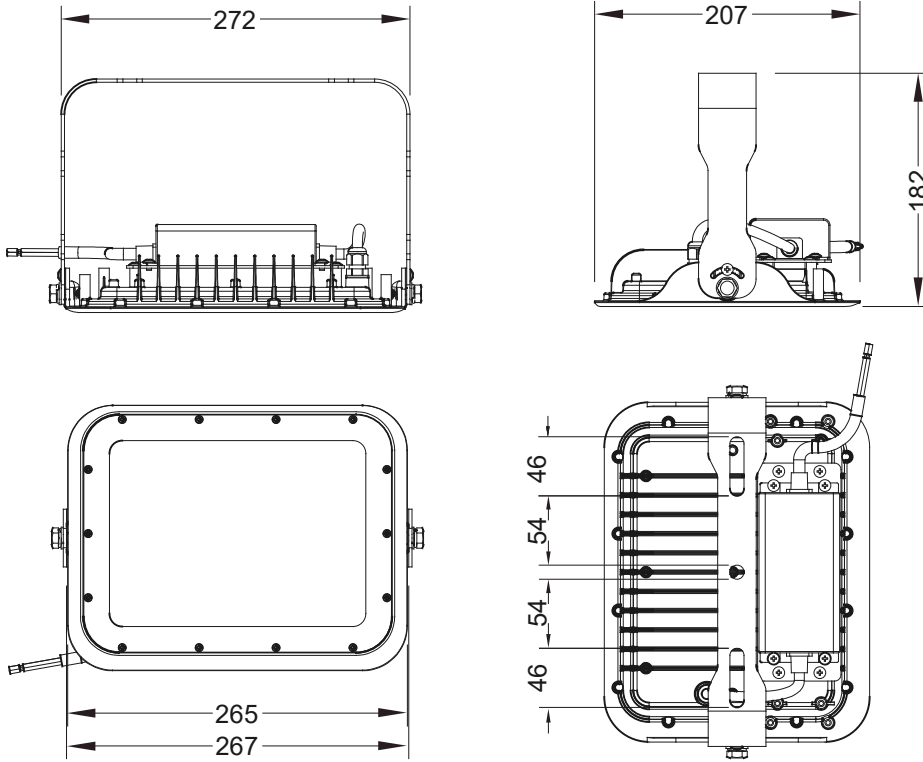

## Application

- Industrial Lighting
- Area Lighting
- Flood Lighting
- General Site Lighting