



TOP HI-TECH CO., LTD.

# Waterproof LED Flood Light



150W, 180W



## Specification Sheet

Design 2020 / 04



+886-2-2267-1234

sales@tht-ex.com

www.tht-ex.com

# Product Features

THT's Flood Light is the high-efficiency lighting system manufactured in Taiwan. It provides quality and comfortable light for various industrial environments. It also has the versatility to be used both in the indoor and outdoor areas with IP66 protection.

The Flood Light offers customers an aesthetic design with exceptional performance and high reliability.

- High system efficacy up to 151 lm/W (Cold stage).
- CCT option available for 3000K, 4000K, 5000K, 6500K.
- Temperature range -30°C to +50°C.
- No IR- and UV radiation, low heat radiation.
- LED lifetime (L70) @55°C 60000hrs.
- Solid die-cast aluminum housing.
- Rotatable bracket made of stainless steel.
- UV rated powder paint coating.
- Equipped with symmetric and asymmetric optical lens.
- Replaceable driver (plug and play system).
- Significant energy savings.
- Flexible LED configurations.



# Specifications

## 150W

Model No.	THTLADA015030H0XXX0	THTLADA015040H0XXX0	THTLADA015050H0XXX0	THTLADA015065H0XXX0
Color Temp.	3000K	4000K	5000K	6500K
Wattage (±10%)	150W	150W	150W	150W
Luminous Flux (±10%)	20,800 lm	21,900 lm	21,900 lm	20,800 lm
Lum. / Wat. (±10%)	139 lm	146 lm	146 lm	139 lm
Input Voltage	100V-277V	100V-277V	100V-277V	100V-277V
Net Weight	5.6 kgs / 12.3 lbs	5.6 kgs / 12.3 lbs	5.6 kgs / 12.3 lbs	5.6 kgs / 12.3 lbs
CRI	≥80Ra	≥80Ra	≥80Ra	≥80Ra
Lens	60°, 120°			
Dimming Options	0-10V dimming			
SPD	L/N 2.5KV ; L,N-FG 5KV			
IP Rating	IP66			
Operating Temp.	-30°C ~ +50°C			
Lifespan	LED lifetime (L70) @55°C 60,000 hrs.			
Warranty	3-year warranty			

## 180W

Model No.	THTLADA018030H0XXX0	THTLADA018040H0XXX0	THTLADA018050H0XXX0	THTLADA018065H0XXX0
Color Temp.	3000K	4000K	5000K	6500K
Wattage (±10%)	180W	180W	180W	180W
Luminous Flux (±10%)	25,000 lm	26,300 lm	26,300 lm	25,000 lm
Lum. / Wat. (±10%)	139 lm	146 lm	146 lm	139 lm
Input Voltage	100V-277V	100V-278V	100V-277V	100V-277V
Net Weight	5.6 kgs / 12.3 lbs	5.6 kgs / 12.3 lbs	5.6 kgs / 12.3 lbs	5.6 kgs / 12.3 lbs
CRI	≥80Ra	≥80Ra	≥80Ra	≥80Ra
Lens	60°, 120°			
Dimming Options	0-10V dimming			
SPD	L/N 2.5KV ; L,N-FG 5KV			
IP Rating	IP66			
Operating Temp.	-30°C ~ +50°C			
Lifespan	LED lifetime (L70) @55°C 60,000 hrs.			
Warranty	3-year warranty			

# Ordering Information

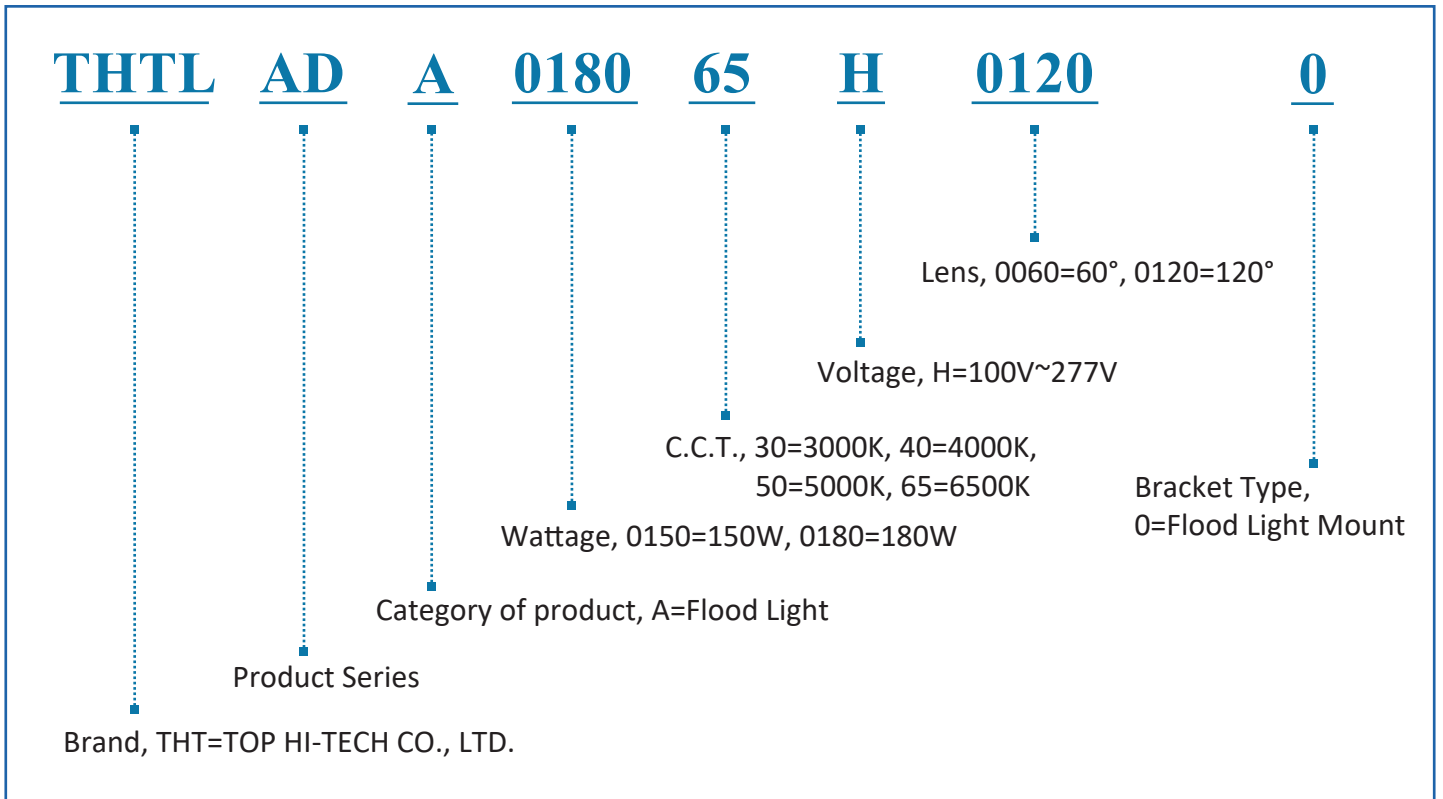

# Light Pattern

60°

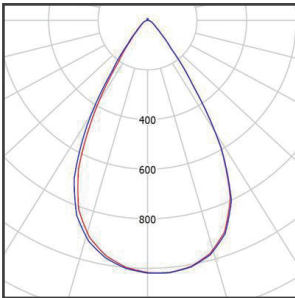

150W LUX (WD,C8)

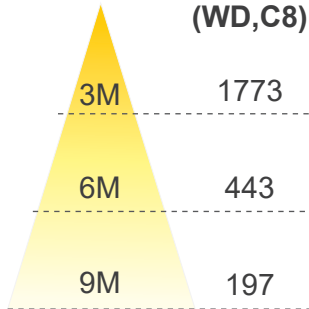

180W LUX (WD,C8)

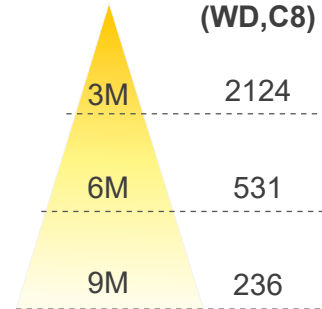

120°

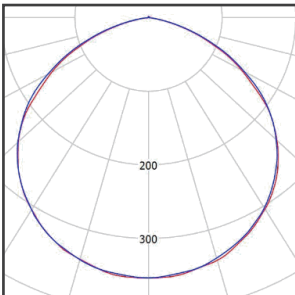

150W LUX (WD,C8)

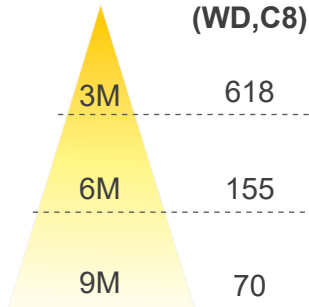

180W LUX (WD,C8)

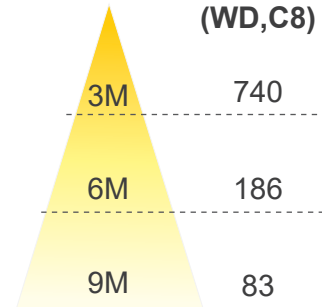

# Dimension Drawing (All in mm)

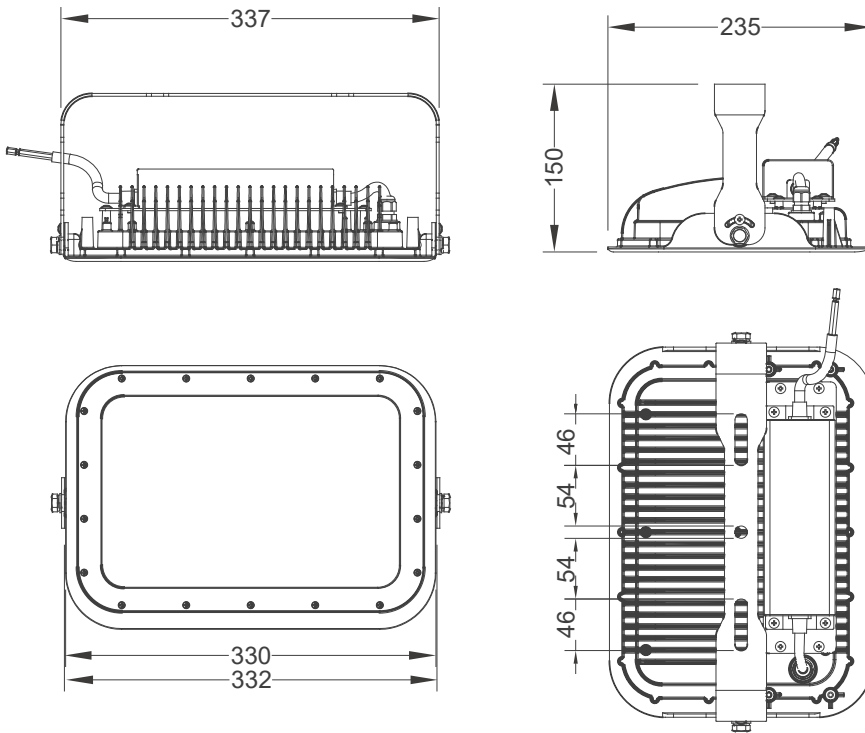

## Application

- Industrial Lighting
- Area Lighting
- Flood Lighting
- General Site Lighting